

Similar Triangles

Booklet

Secondary 4

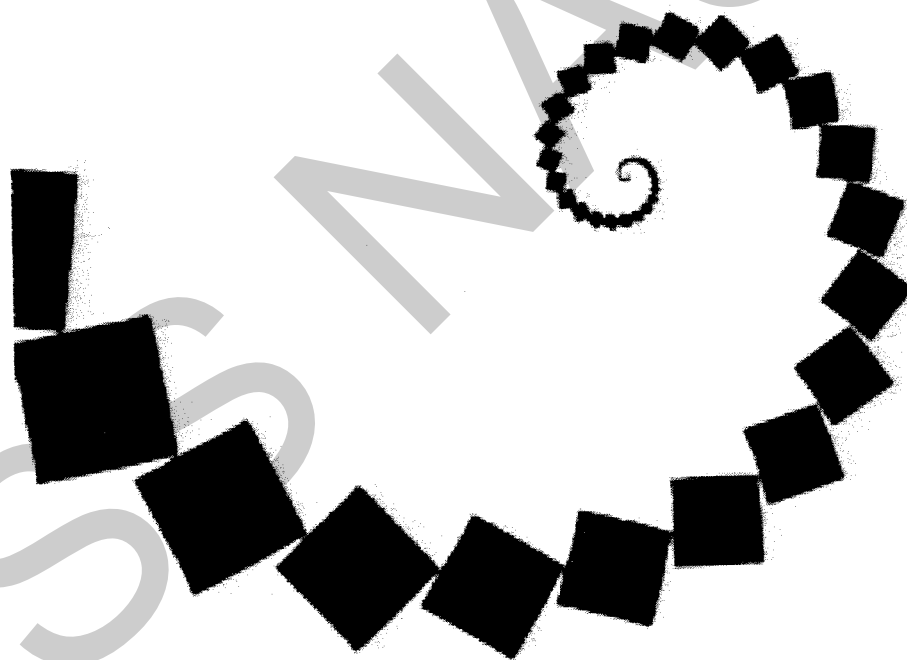

Ms. Nassif

SIMILAR TRIANGLES

Determine if the following triangles are similar. By which rule?
SHOW WORK FOR PROPORTIONS.

1)

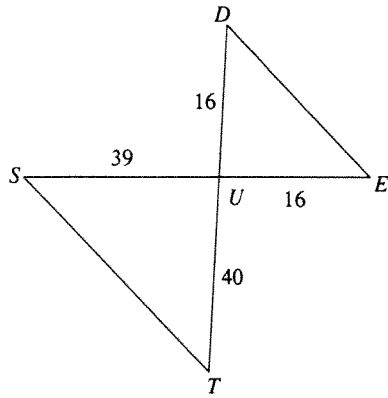

2)

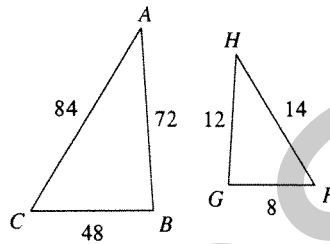

3)

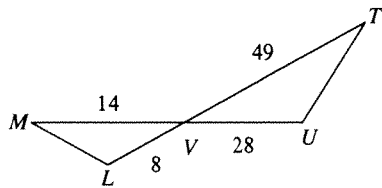

4)

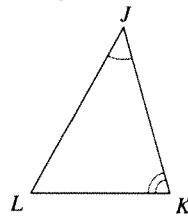
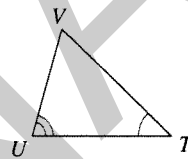

5)

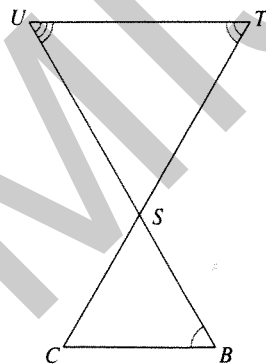

6)

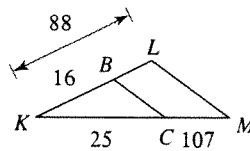

7)

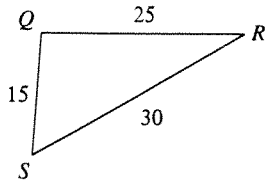
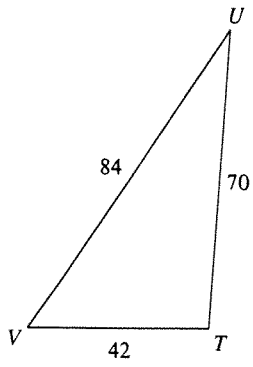

8)

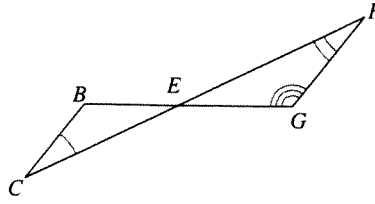

9)

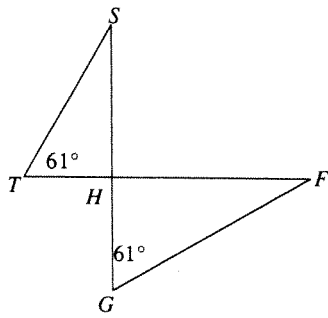

10)

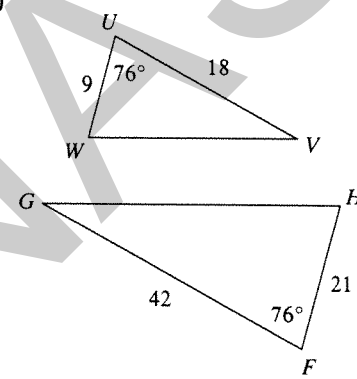

11)

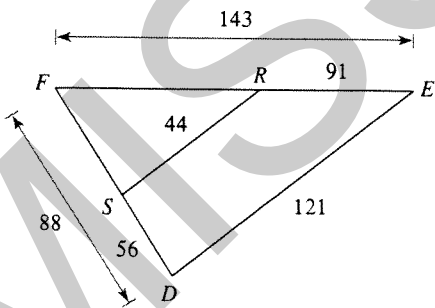

12)

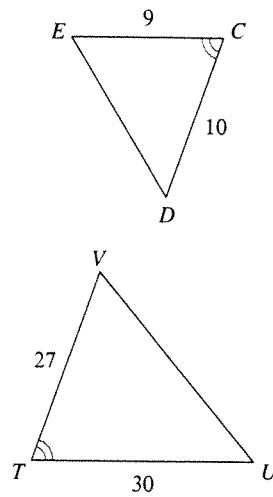

State if the triangles in each pair are similar. If so, state how you know they are similar.

1)

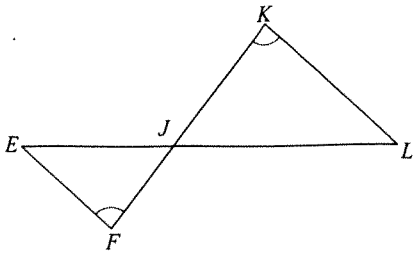

2)

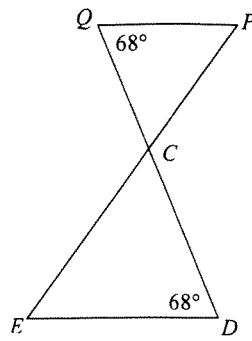

3)

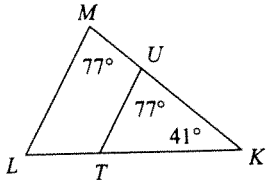

4)

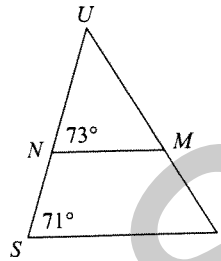

5)

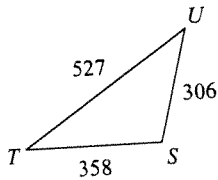
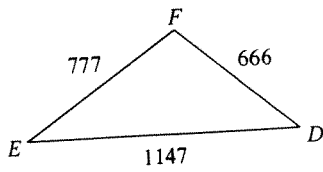

6)

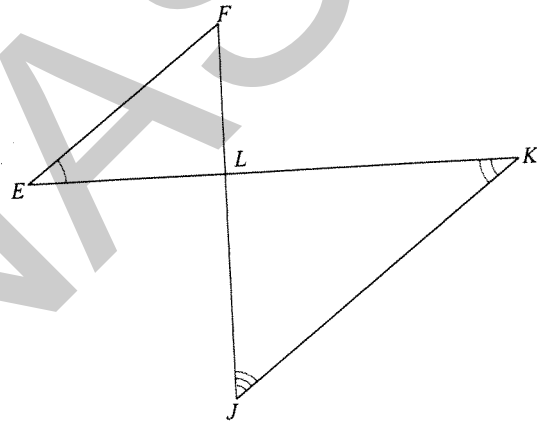

7)

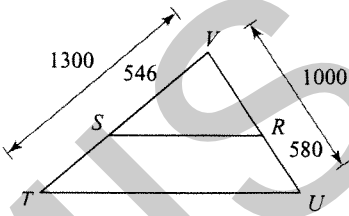

8)

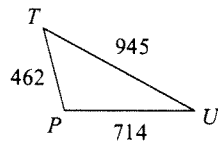
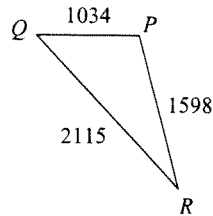

9)

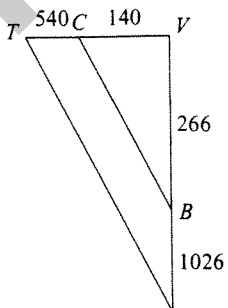

10)

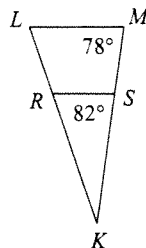

For 1 – 6, determine if the triangles are similar by AA, SSS, SAS or none

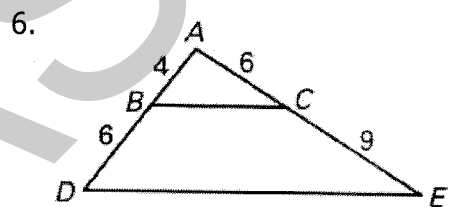
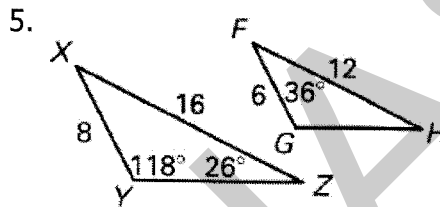
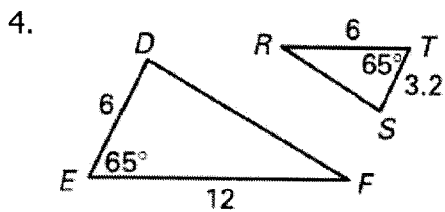
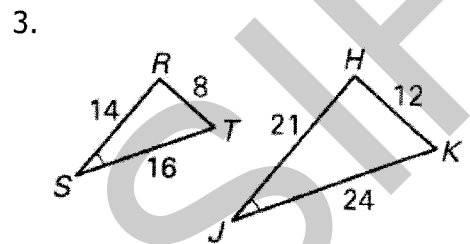
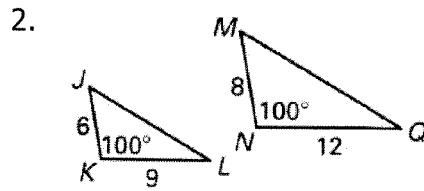
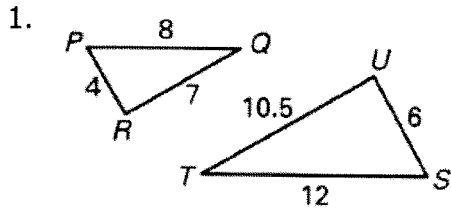

For 7 and 8, determine if $\triangle PQR$ or $\triangle MNO$ is similar to $\triangle ABC$.

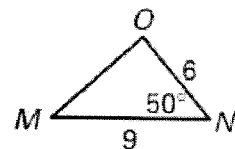
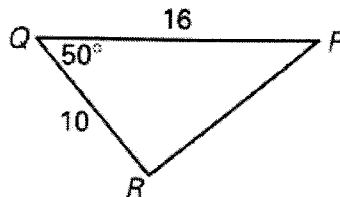
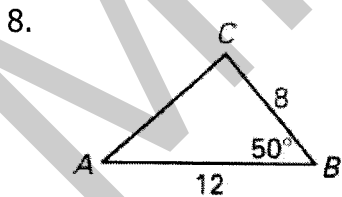
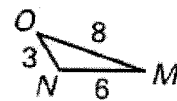
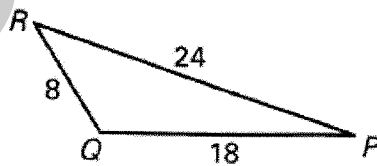
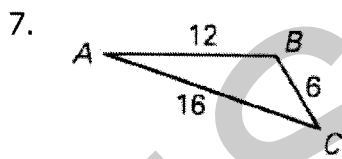

Similar Figures

Each pair of figures is similar. Find the missing side.

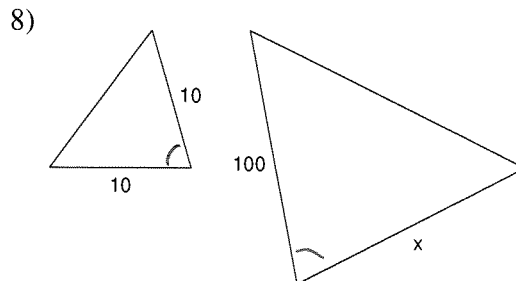
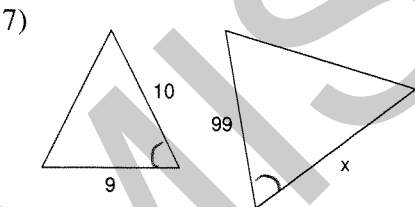
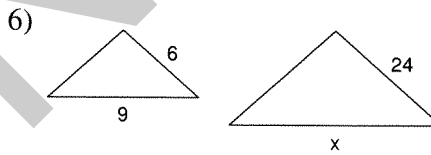
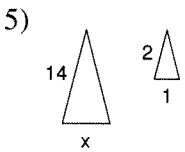
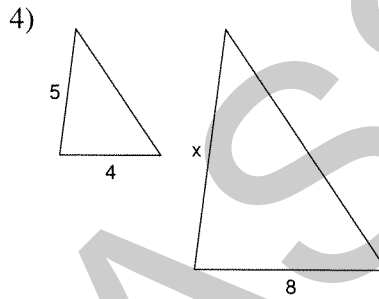
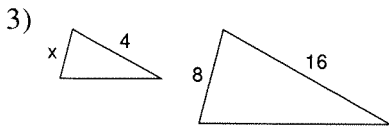
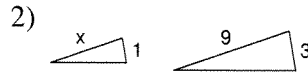
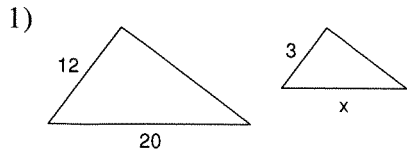

9)

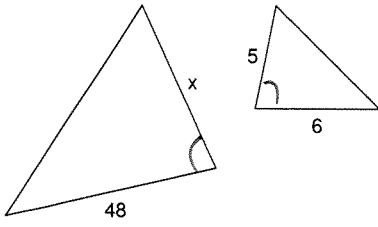

10)

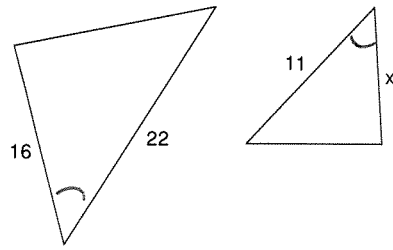

11)

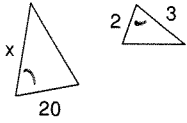

12)

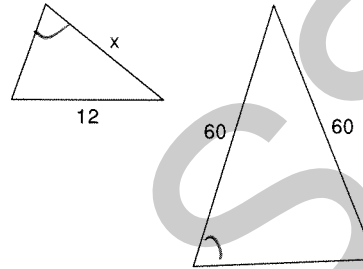

13)

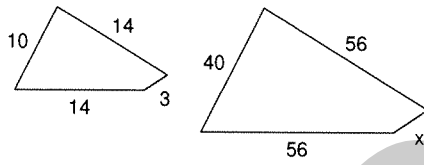

14)

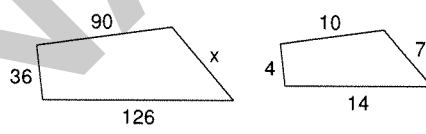

15)

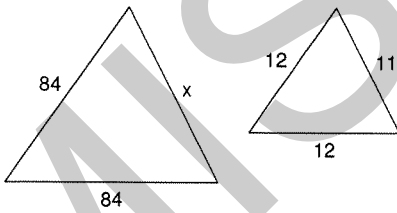

16)

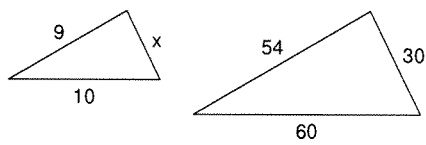

17)

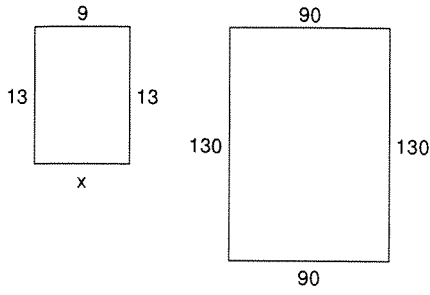

18)

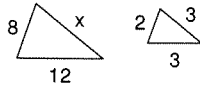

19)

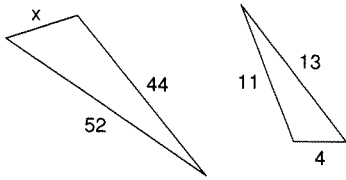

20)



21)

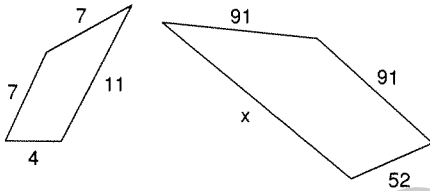

22)

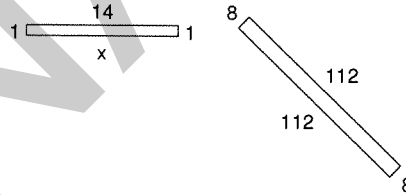

23)

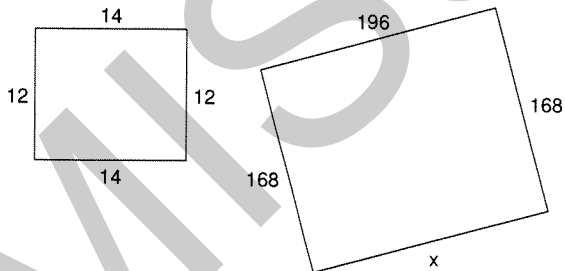

24)

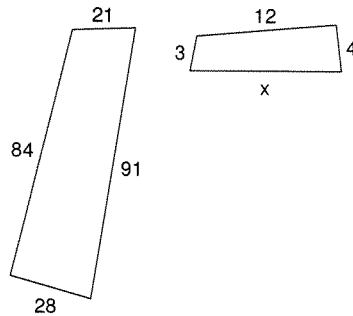

Find the missing length indicated.

1)

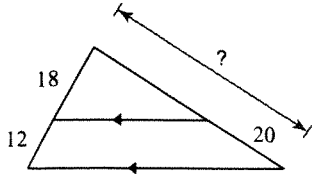

2)

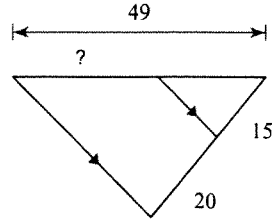

3)

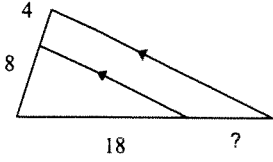

4)

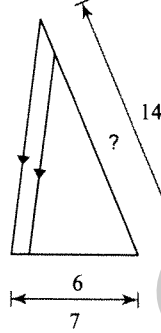

5)

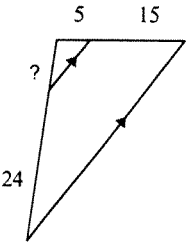

6)

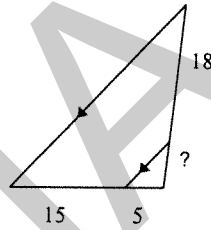

7)

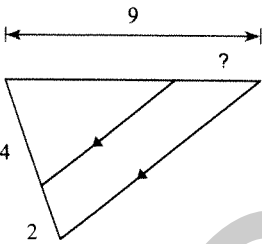

8)

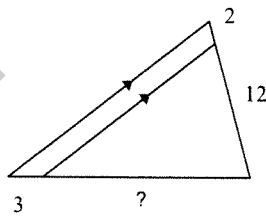

9)

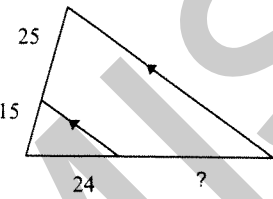

10)

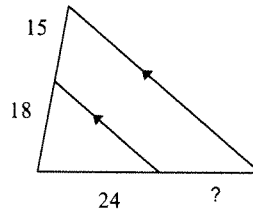

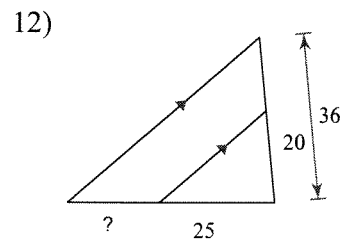
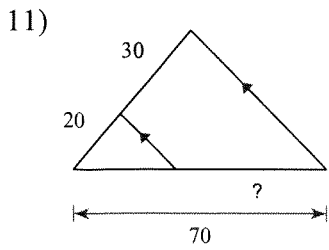

Solve for x .

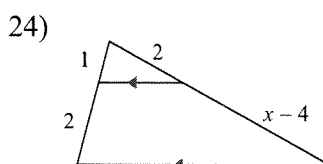
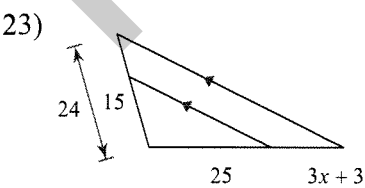
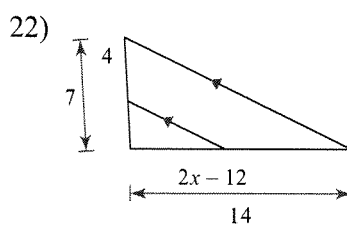
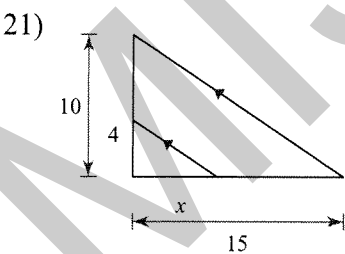
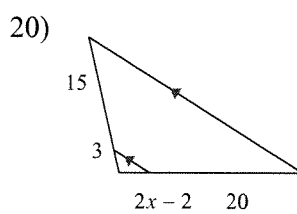
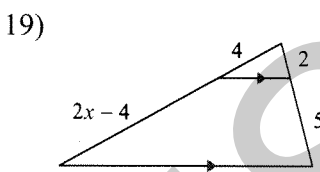
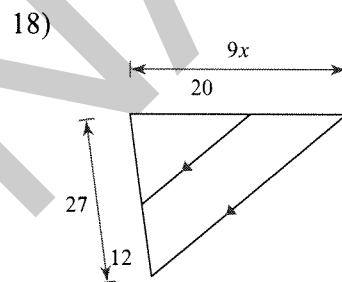
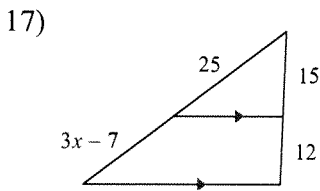
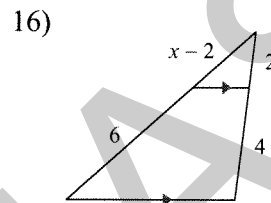
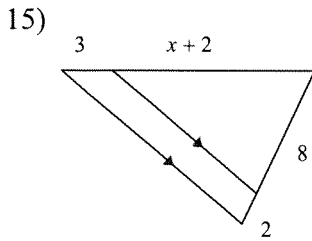
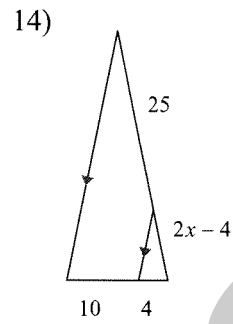
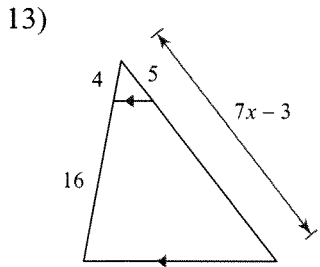

Find the missing length. The triangles in each pair are similar.

13)

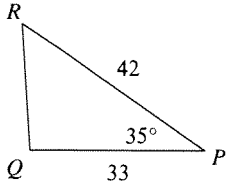
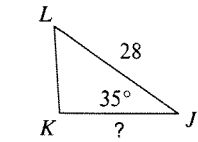

14)

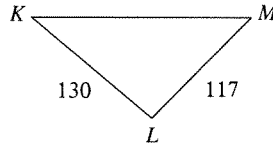
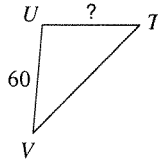

15)

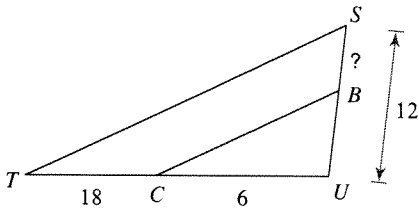

16)

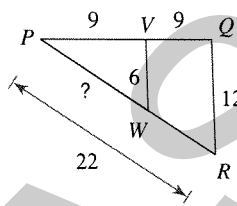

Solve for x . The triangles in each pair are similar.

17)

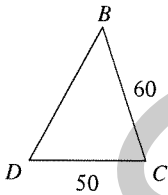
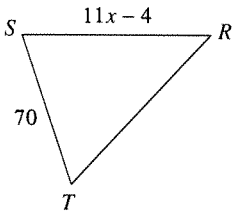

18)

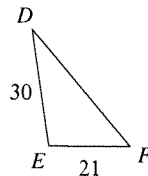
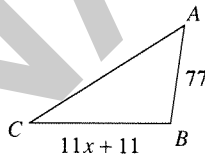

19)

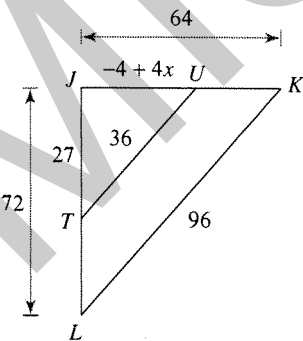

20)

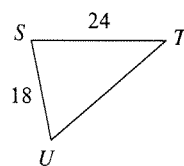
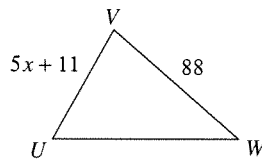

Find the missing length. The triangles in each pair are similar.

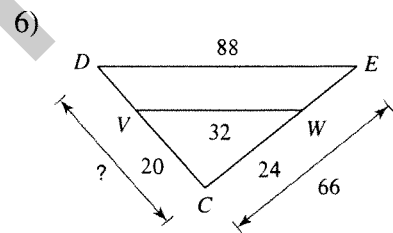
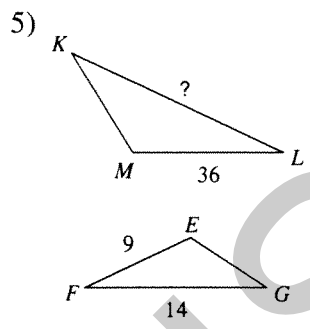
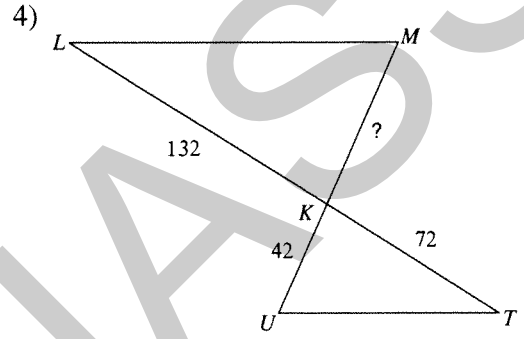
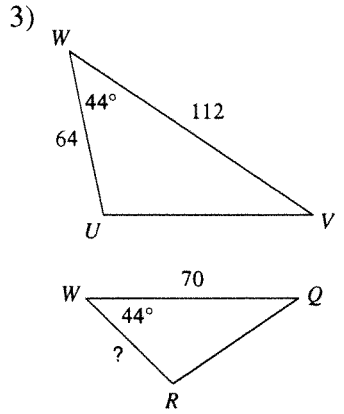
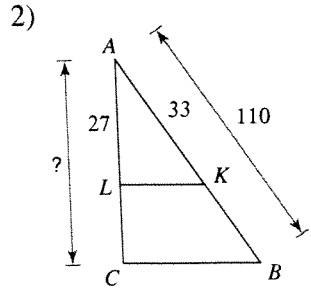
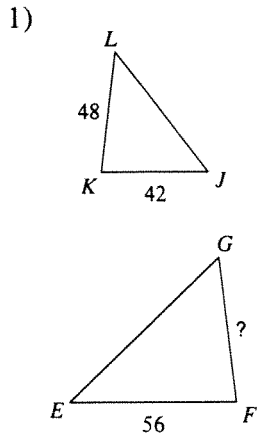

7)

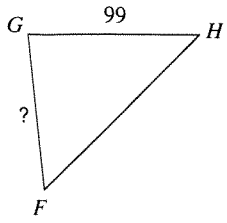
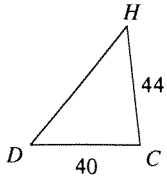

8)

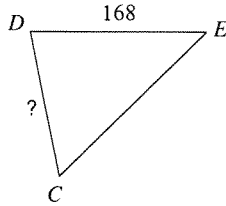
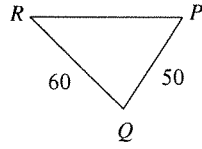

9)

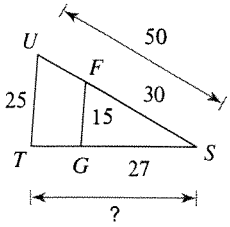

10)

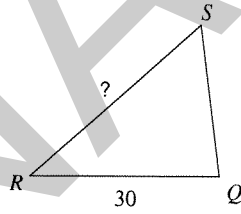
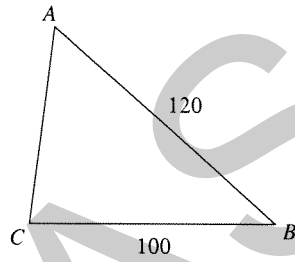

11)

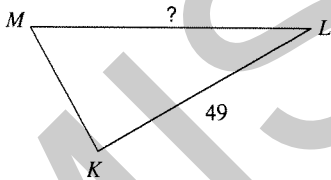
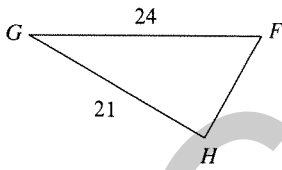

12)

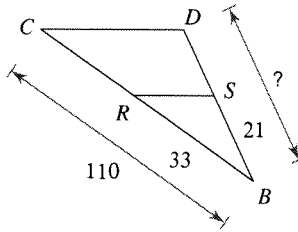

13)

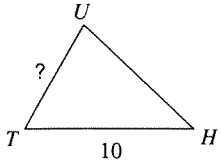
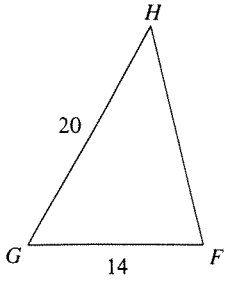

14)

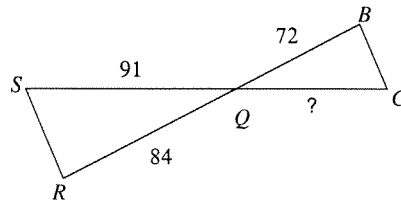

15)

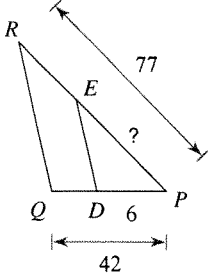

16)

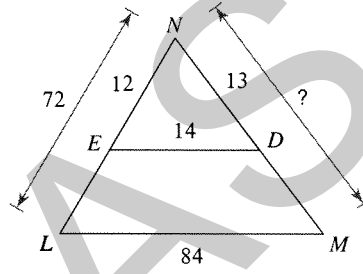

17)

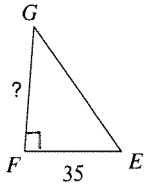
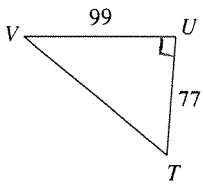

18)

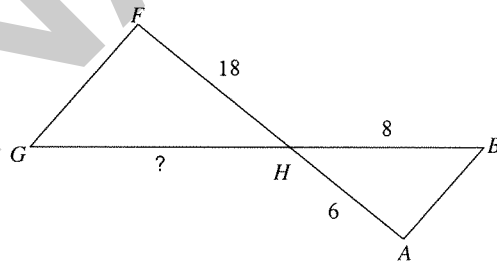

19)

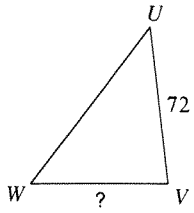
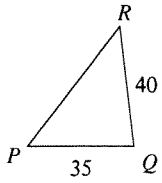

20)

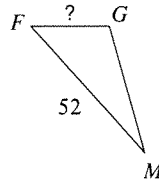
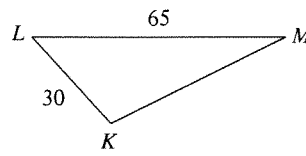

Solve each proportion.

21) $\frac{v}{2} = \frac{2}{10}$

22) $\frac{7}{x} = \frac{4}{6}$

23) $\frac{x}{3} = \frac{3}{2}$

24) $\frac{7n}{5} = \frac{6}{9}$

25) $\frac{6}{3} = \frac{10}{k}$

26) $\frac{7}{p} = \frac{5}{7}$

27) $\frac{5}{n} = \frac{6}{7}$

28) $\frac{8}{2} = \frac{9}{4x}$

29) $\frac{8}{r} = \frac{7}{6}$

30) $\frac{m}{10} = \frac{4}{5}$

Find the missing length. The triangles in each pair are similar.

1)

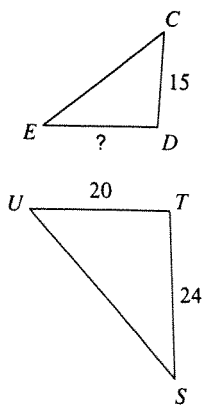

2)

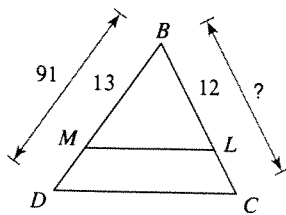

3)

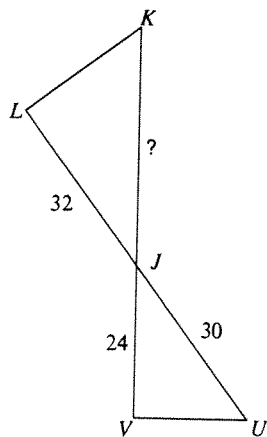

4)

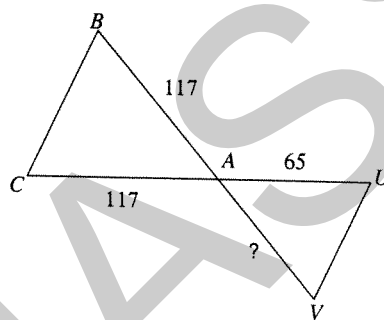

5)

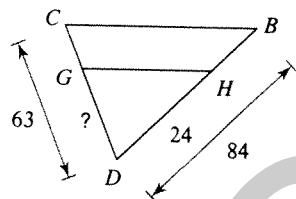

6)

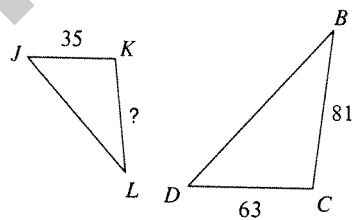

Solve for x . The triangles in each pair are similar.

7)

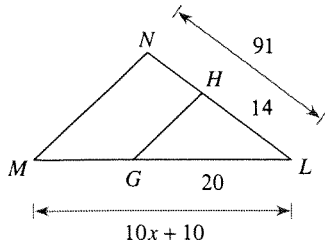

8)

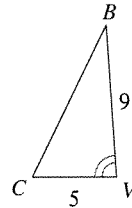
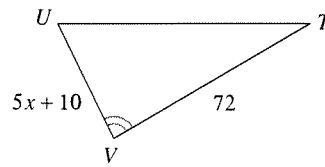

9)

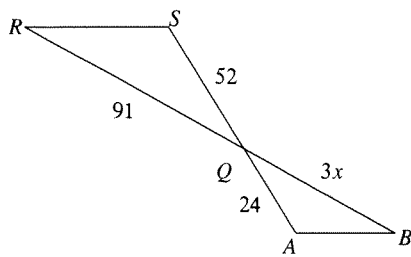

10)

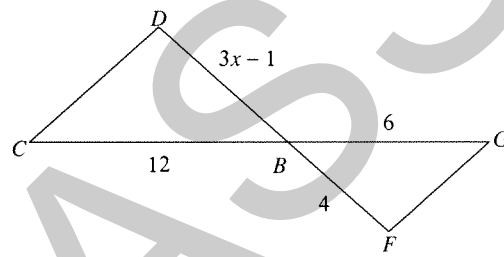

11)

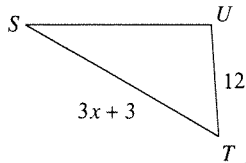
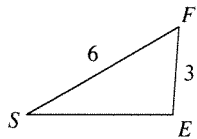

12)

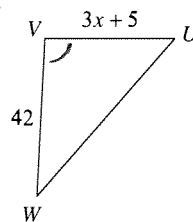
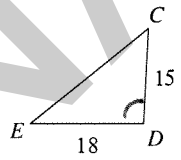

Solve for x . The triangles in each pair are similar.

13)

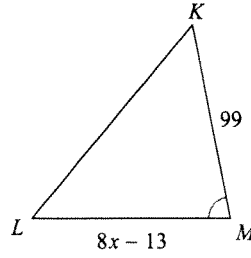
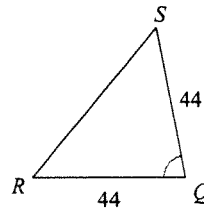
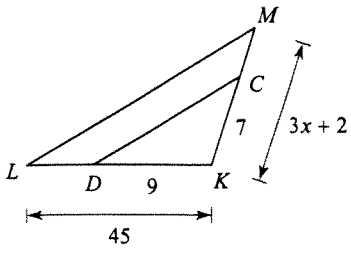

15)

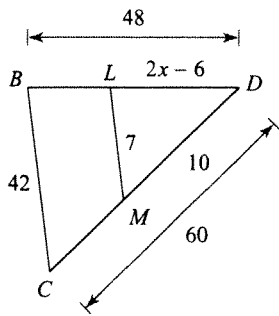

16)

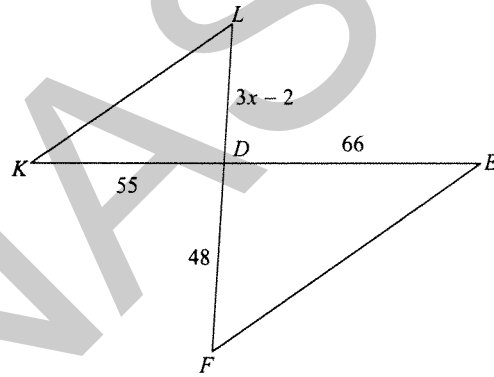

17)

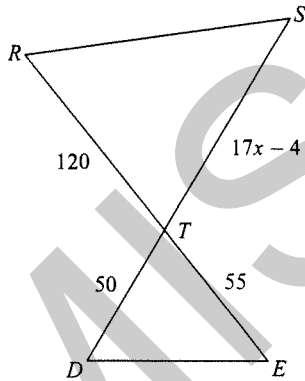

18)

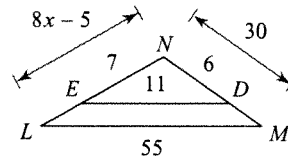

18

19)

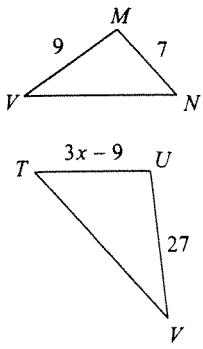

20)

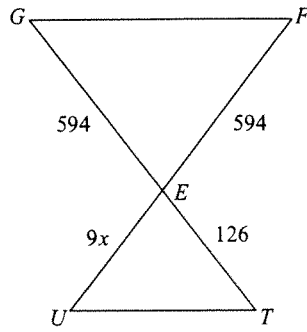

21)

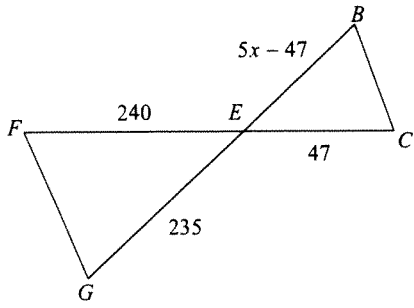

22)

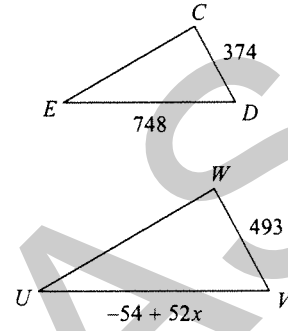

23)

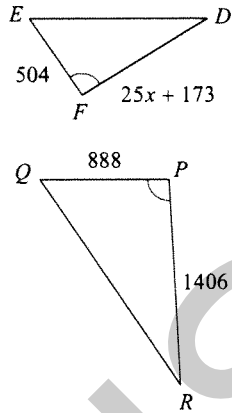

24)

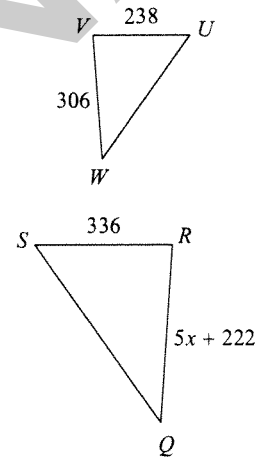

Solve for x .

1)

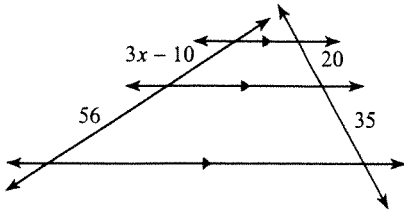

2)

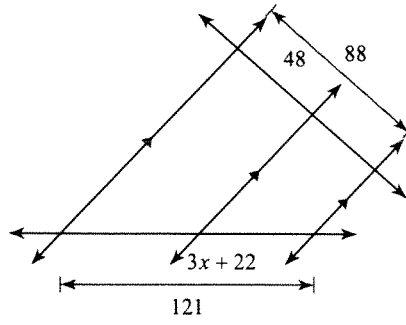

3)

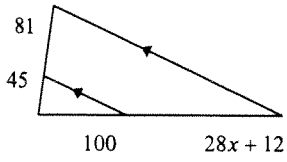

4)

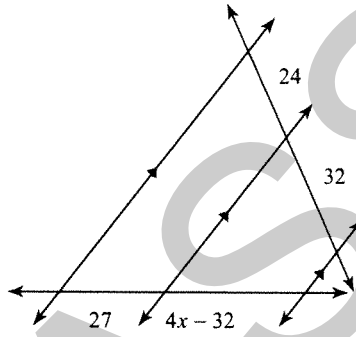

~~5)~~

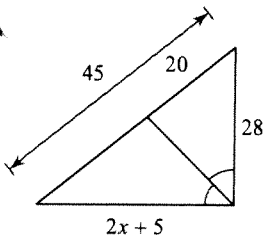

6)

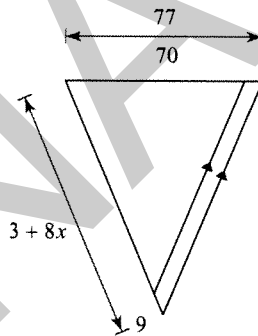

~~7)~~

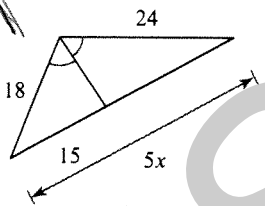

8)

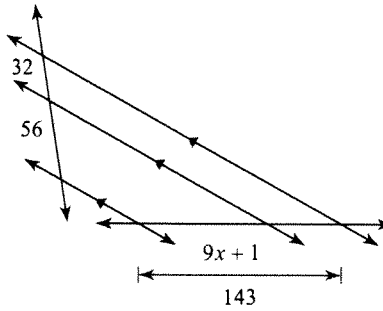

Determine whether the triangles are similar. State how you know they are or are not similar.

9)

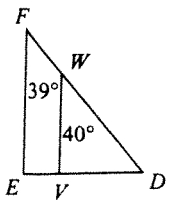

10)

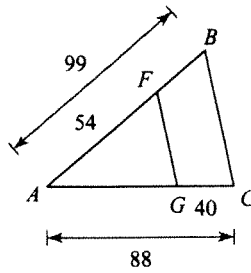

11)

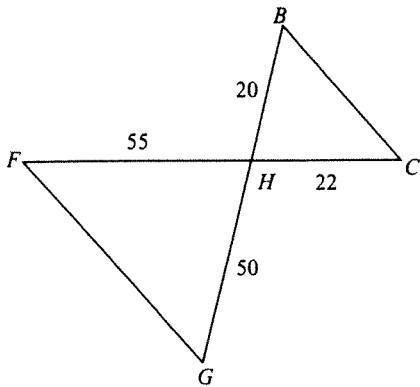

12)

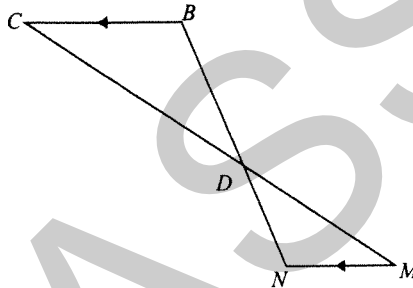

Find the missing length that would make the triangles similar.

13)

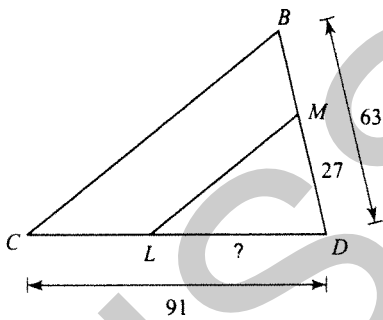

14)

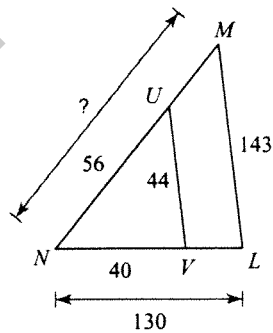

Similar Triangles Review

1. Given $\triangle RST$ is similar to $\triangle ABC$.

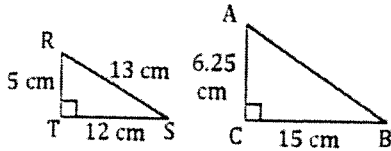

What is the length of segment AB?

2. Given quadrilateral PQRS similar to quadrilateral WXYZ.

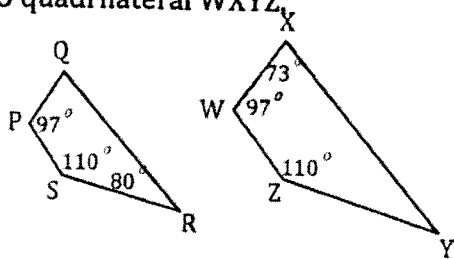

What is the measure of $\angle Q$?

16. In the figure, triangle ABC is similar to triangle XYC.

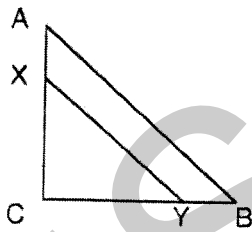

If $XY = 11$ cm, $CY = 10$ cm, and $BC = 15$ cm, what is the length of segment AB, in centimeters?

- For 3 - 4, $\triangle ABC$ is similar to $\triangle RST$.

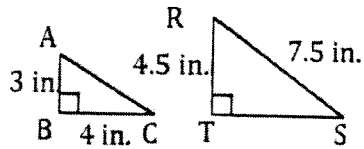

3. What is the length of side AC?

4. What is the length of side ST?

5. Rectangle PQRS is similar to rectangle WXYZ. What is the length of side RS?

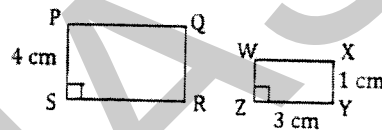

6. The two squares are similar.

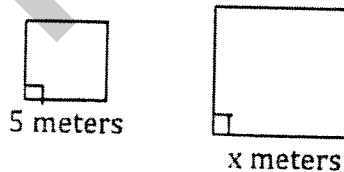

If their scale factor is $\frac{4}{5}$, what is the length of side x ?

20. Last week John painted the front of a rectangular solid with a 15-meter base edge.

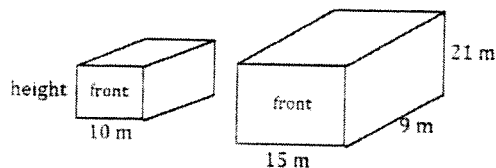

This week he must paint the front of a smaller similar rectangular solid with a 10-meter base edge. What is the height of the smaller similar solid?

For 7 - 8, the scale factor between the two similar rectangular solids is $\frac{3}{4}$.

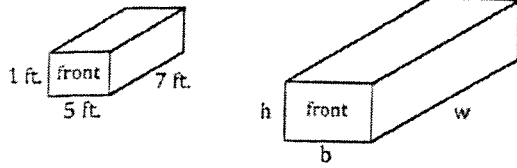

7. What is the length of side b on the front of the larger rectangular solid?
8. What is the length of side h on the front of the larger rectangular solid?
9. The two cones below are similar and have a scale factor of $\frac{1}{5}$.

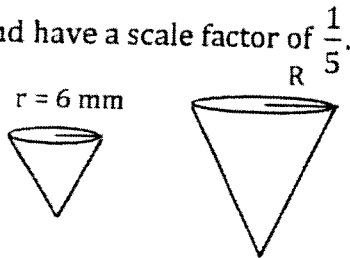

What is the radius of the larger cone?

For 13 - 15, the two trapezoids shown are similar.

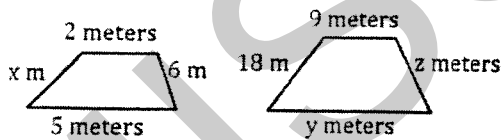

13. Find the value of x.
14. Find the value of y.
15. Find the value of z.

10. The two rectangular pyramids are similar.

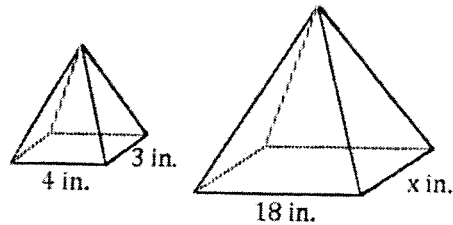

What is the length of the smaller base edge of the larger pyramid, if the sides of the base of the smaller pyramid are 4 inches and 3 inches?

11. A 20-foot tree casts a 45-foot shadow at the same time a building casts a 243-foot shadow.

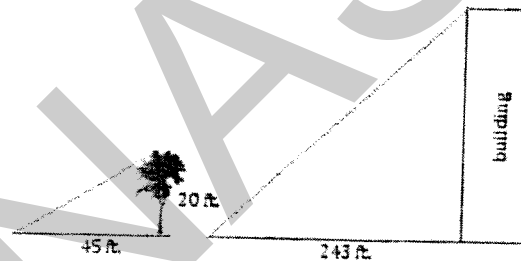

What is the height of the building?

18. In the figure below triangle ACB is similar to triangle DEB.

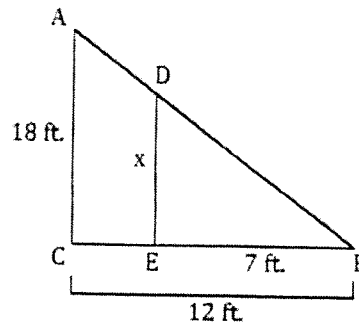

If AC = 18 feet, CB = 12 feet, and EB = 7 feet, what is the length of segment DE?

4. Study the two triangles shown.

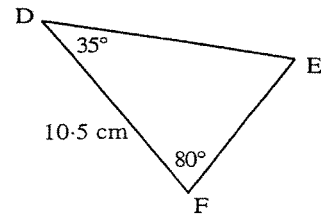
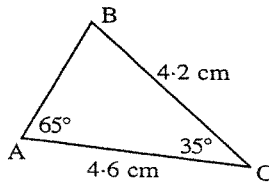

- Explain clearly why the two triangles must be similar.
- Use the fact that the two triangles are similar to calculate the length of the line DE.

5. Triangles ABE and ACD with some of their measurements are shown opposite.

Triangle ABE is similar to triangle ACD.
Calculate the length of BE.

Do not use a scale drawing.

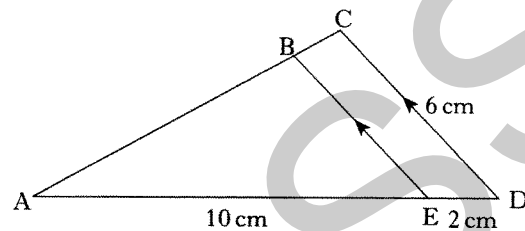

6. The brown family want to convert the roof space in their bungalow into an extra room.

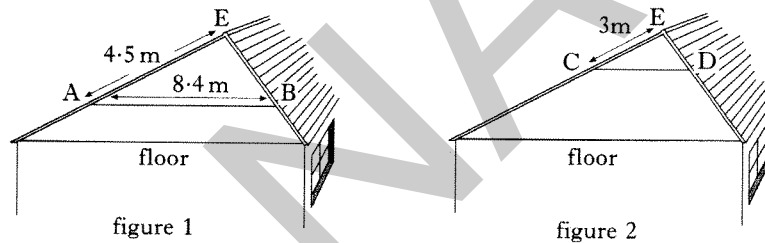

The position, AB, of the wooden beam must be changed to position CD, as shown in figure 2.

The wooden beam must always be parallel to the floor.

By considering the similar triangles EAB and ECD, calculate the length of the wooden beam in position CD.

Do not use a scale drawing.

7. By holding a 10 pence coin at arms' length, it is possible to cover exactly the face of a person standing a distance away.

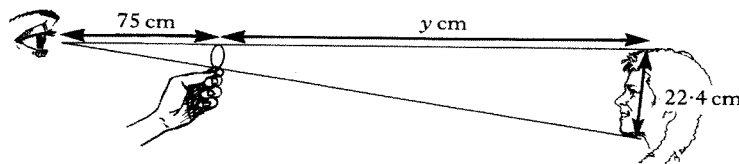

The diameter of the 10 pence coin is 2.8 cm and the length from the top to the bottom of the person's face is 22.4 cm.

If the distance from the observer's eye to the top of the coin is 75 cm, find the distance from the top of the 10 pence coin to the top of the person's head.